

Vicino  
la culla dei sogni

For a good sleep



CONTINENTAL AND UPHOLSTERED BEDS



# TABLE OF CONTENTS

- Who are we? .....4
- Vicino brand.....5
- What is a continental bed?.....6
- What is worth considering when buying a bed?.....6
- Types of continental beds.....8
- 9 steps to choosing a bed.....10
- Mattress types .....16
- Headrests and footrests.....18
- Top mattress types.....22
- Alor collection.....24
- Rossa collection.....26
- Senje collection.....28
- Daru collection.....30
- Storage collection.....32
- Headboard models.....34
- What is an upholstered bed.....42
- Feasy matters.....42
- Types of upholstered beds .....44
- Uno collection.....46
- Los collection.....50
- Accesories.....58

IN THE PICTURE ON THE LEFT:  
electric bed (MOTION) with a small box (SLIM), Headboard from MANUS collection

IN THE COVER PHOTO:  
electric bed (MOTION) with small box (SLIM), Headboard from FRASER FLY collection



## WHO ARE WE?



We would like to introduce the VICINO brand created by Bovelli Bedding Sp. z o.o. Bovelli is a recognized Polish manufacturer of upholstered furniture, specializing in the production of continental beds with mattresses, headrests and pouffes.



The quality of our products is appreciated by Europeans from many EU countries who for years have been sleeping healthily and comfortably on continental beds produced by Bovelli Bedding sp. z o.o. Our products combine Polish quality and workmanship, Belgian experience and Italian finesse.



We put all our passion and love of beauty into making our beds. We pay a lot of attention to care for natural environment. We use natural raw materials in our beds, we also have modern, environmentally friendly technological lines. We are a family company and we care that our children live in a clean world and a healthy climate.



The company has won numerous awards and distinctions. It has been appreciated both as a trustworthy partner, a thriving exporter to European markets and a promoter of Polish design. It also actively supports various charity campaigns.

IN THE PICTURE BELOW:  
classic bed with opening box (STORAGE), Headboard from the CAMPANA collection



## VICINO BRAND



The VICINO brand is the result of an analysis of our products and approach to life. Vicino reads as close in the sense of both physicality and spirituality. The slogan *La culla dei sogni*, translated from Italian: the cradle of dreams, perfectly reflects what we would like to offer in our products.



Ergonomics, functionality and durability are the most important features of our beds. Equally important to us are beauty, high quality and modern design as well as the materials used to make the beds.



It is easy to calculate that a person sleeps about 20 years, on average, during their lifetime! Hence, the selection of the right bed is extremely important for our health and mental well-being. Please note that there is no universal bed. As people and their needs are different, so are beds.



So how do you choose the right bed for you? We will advise you step by step on what you should be looking for when buying a bed that will optimally provide what is best for your health.

ON THE PICTURE BELOW  
electric bed (MOTION) with a large box (NORMAL) Headboard from SHERMAN collection



## WHAT IS A CONTINENTAL BED?



A Continental bed, also called a BOX SPRING, is a piece of bedroom furniture with built-in springs, a mattress and an additional top mattress, called a topper.



These types of beds are high, which makes them comfortable and especially suitable for people with health problems. The top layer of the mattress is at a height from 62 cm.



Let us remember that in our homes and apartments, the bedroom is one of the most important rooms. It is a place of intimacy and closeness with another person, it is our sanctuary from the surrounding world.

# 1

**BOX BASE**  
made of  
solid wood frame  
and 7-zone  
pocket spring

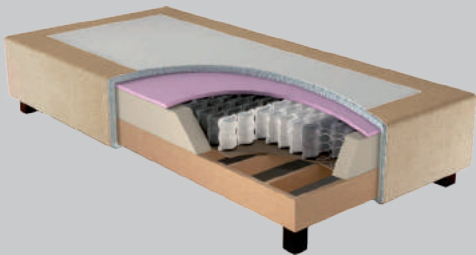

# 2

**MATTRESSES**  
are made  
with seven zones  
of hardness, arranged  
in accordance with  
a human's anatomical  
structure

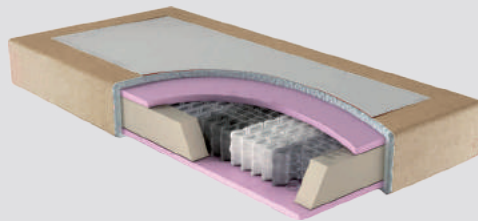

# 3

**TOPPER,**  
a top mattress  
with different levels  
of flexibility, which  
also serves to unite  
the main mattress  
into one surface.

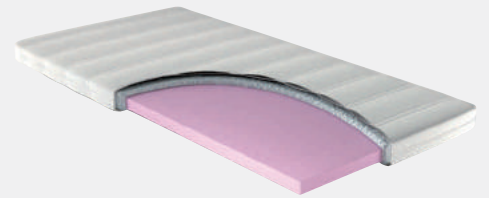

## WHAT IS WORTH CONSIDERING WHEN BUYING A BED?



**SIZE OF THE ROOM.** Remember to maintain the appropriate ergonomics. It is a good idea to provide sufficient space between the bed and other bedroom furniture. The minimum recommended distance is 60 cm.



**ORIENTATION OF THE BED** towards the morning sun. Orientation of the bed to the east or possibly northwest is recommended.



**THE SIZE OF THE BED** that we choose is precisely determined by how much space we have in the bedroom, among other things.



**FUNCTIONALITY OF THE BED,** a choice between wanting a classic bed (FIXED) or a movable bed with an electric motor (MOTION). It is worth paying attention to whether we need a bed with a bedding container (STORAGE).



ON THE PICTURE: Classic bed (NORMAL) with small box (NORMAL). Headboard from CLARENCE collection

# TYPES OF CONTINENTAL BEDS

The VICINO continental bed configurator below will assist you in making the right choice of individual elements to meet your needs and requirements

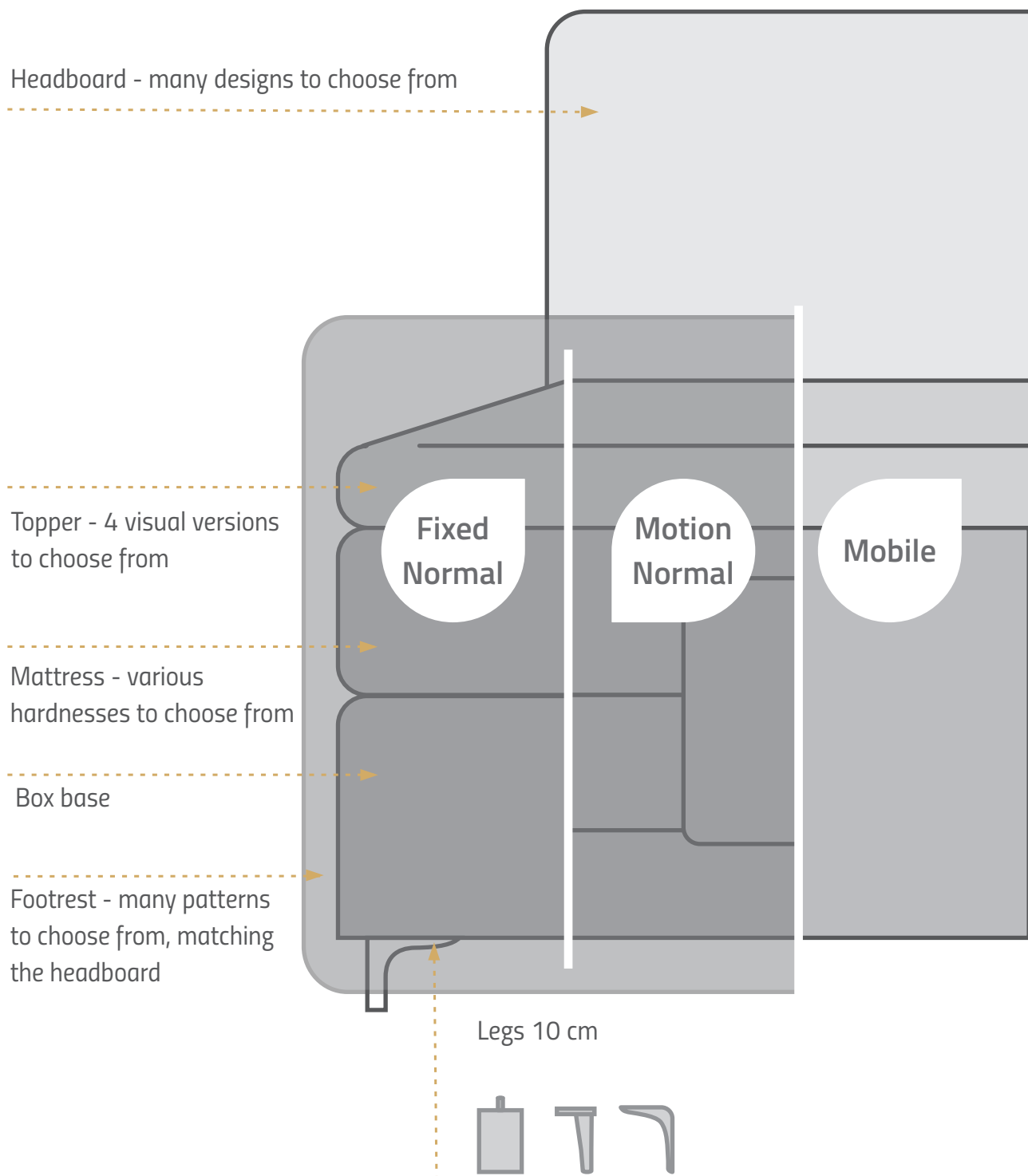



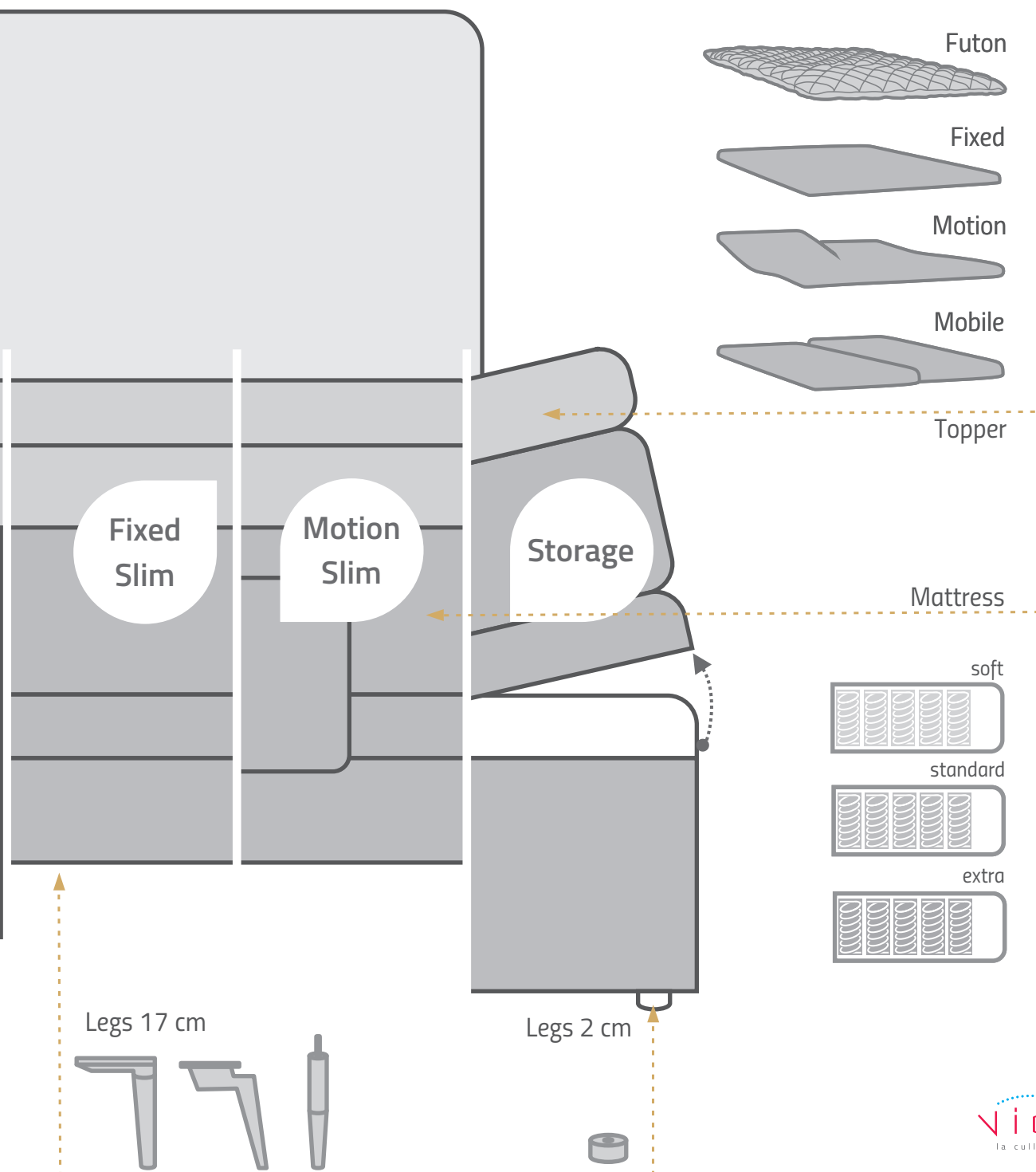

01



## 9 STEPS TO CHOOSING A BED

### FUNCTIONALITY

- CLASSIC BED (Fixed) \* a bed with a static structure on a solid wood base
- ELECTRIC BED (Motion) \*the lower frame is equipped with a bed-lifting mechanism controlled with a remote control
- MOBILE BED (daru colletion) low, wooden box with two separate mattresses. It can be divided into two separate single beds or coupled into a double, with replaceable covers
- STORAGE BED (koofer colletion) a bed with a bedding container, e.g., for extra sheets

NOTE: The above beds may be equipped with a mechanism that lifts only one side of the bed, with the other remaining static, hence making the bed half-classic and half-electric. The solution is especially recommended for couples with different spinal conditions.

FOR DETAILS SEE PAGE 14

02



### EXTERNAL APPEARANCE

- LARGE BOX SPRING (Normal)\*
- SMALL BOX SPRING (Slim)\*

In both cases the total height of the bed is 62 cm

\*NOTE: The two beds are of equal height. The thickness difference of the boxes does not affect the height of the beds. The height difference of the boxes is leveled by the height of the legs.

\*NOTE: for classic (Fixed) and electric (Motion) beds only, skip this step for mobile and box spring beds

FOR DETAILS SEE PAGE 14

03



### THE SIZE OF THE BED AND MATTRESS

Double Bed - the bed has two separate bases.

A single bed is available in the following widths:  
70 /80 /90 /100 /120 cm.

A double bed is available in the following widths:  
140 /160 /180 /200 cm.

The beds are available in the following lengths:  
200 /210 /220 cm

You can choose two single mattresses or one double mattress (e.g. for a bed 140 cm wide you can choose one 140 cm or two 70 cm mattresses).

FOR DETAILS SEE PAGE 14

## FIRMNESS OF A MATTRESS

The feeling of mattress firmness is a subjective assessment of each user. The purpose of a mattress is to provide proper support for the body and the spine during sleep.

During sleep, the spine should be kept in a stable position, in a straight line.

FOR DETAILS SEE PAGE 16

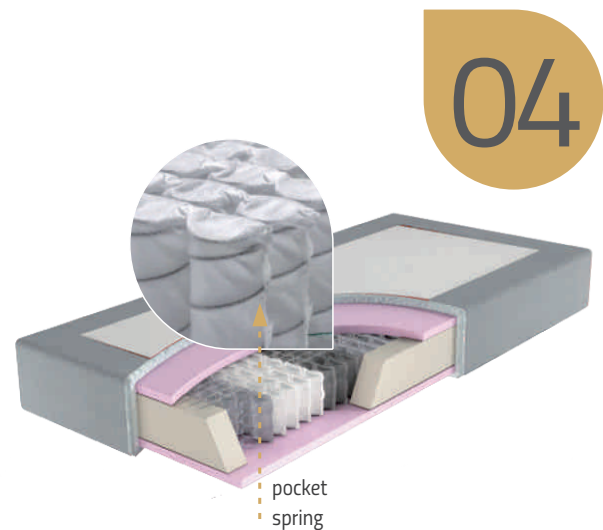

## HEADBOARD AND FOOTBOARD

The choice of a headboard does not affect the comfort of sleep. It depends on the individual preferences of the users. Our offer includes over a dozen different designs of headboards for continental beds

The choice of footboard is optional. If selected, it is equal to the width of the respective bed size.

NOTE: The headboards offered in all our collections are available in different widths ranging. The height of the headboard depends on the model.

FOR DETAILS SEE PAGE 18



## FABRIC

We offer a selection of over 30 types of upholstery fabrics. The fabric does not affect the comfort of sleep. It depends on the individual preferences of the users.

The types of fabrics change depending on fashion trends. The current selection of fabrics is available at <https://www.vicino.eu>.



07



## MATTRESS TOPPER

A topper improves comfort of rest, protects the mattress from damage or dirt and allows to adjust the firmness to individual needs. The topper is usually 8 cm thick or 10 cm thick for the Futon model.

It can be made of polyurethane foam, thermoelastic foam, latex or gel filling.

FOR DETAILS SEE PAGE 22

08



## LEGS

Our offer includes a number of different leg types. For small box SLIM we recommend the 17-cm legs, for large box NORMAL the 10-cm legs. STORAGE beds – the 2-cm legs .

FOR DETAILS SEE PAGE 58

09



## ACCESSORIES

A selected bed may be complemented by a bedding container, a cushion and/or a bedcover or night table.

FOR DETAILS SEE PAGE 58

CHOOSE VICINO BED  
AND ENJOY A GOOD NIGHT'S SLEEP



ON THE PICTURE: Classic bed (NORMAL) with a large box (FIXED), headboard from ALOR collection

**Fixed  
Normal**

Frame of solid wood, 7-zone pocket spring with a height of 13 cm, top quality furniture foam. Mattress and topper can be chosen according to your personal taste.



- 01 FUNCTIONALITY
- 02 EXTERNAL APPEARANCE
- 03 THE SIZE OF THE BED AND MATTRESS

Topper 8-10 cm

Mattress 19 cm

Box Fixed Normal 27 cm

Legs 10 cm

Length (cm) 200 / 210 / 220

Width (cm) 70 / 80 / 90 / 100 / 120

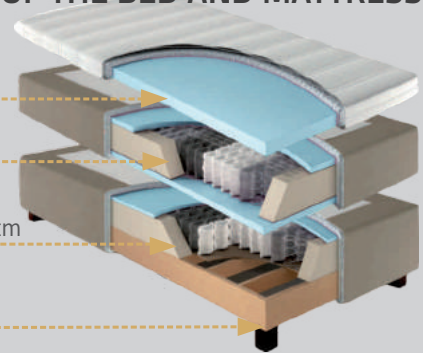

**Motion  
Normal**

The model consists of a frame with a bed lifting mechanism. The frame is made of solid wood, 7-zone pocket spring with a height of 13 cm, top quality furniture foam. The mattress and topper can be chosen according to personal preference.



Topper 8 cm

Mattress 19 cm

Box Motion Normal 15 cm

Wooden frame 12 cm

Legs 10 cm

Length (cm) 200 / 210 / 220

Width (cm) 70 / 80 / 90 / 100

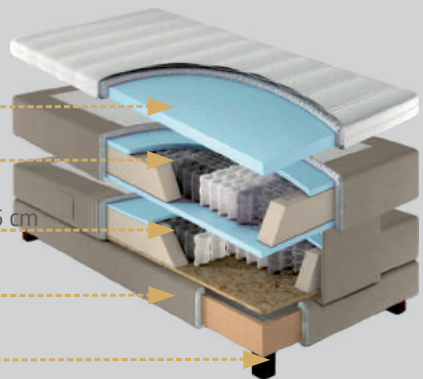

**Mobile**

MOBILE Solution mainly for commercial clients. It is characterized by easily replaceable cover and easy to carry. The 5-element Mobile system provides the possibility of configuring the arrangement of individual parts.



Topper 8 cm - 10 cm

Top mattress 19cm

Bottom mattress 14 cm

Wooden frame 12 cm

Legs 10 cm

Length (cm) 200 / 210 / 220

Width (cm) 70 / 80 / 90 / 100 / 120

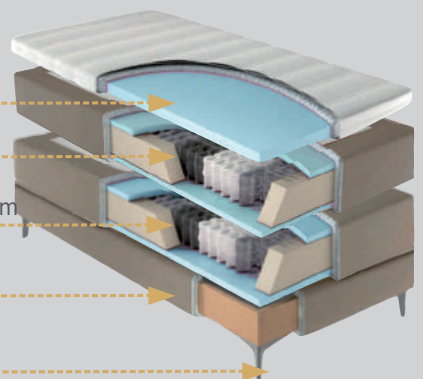

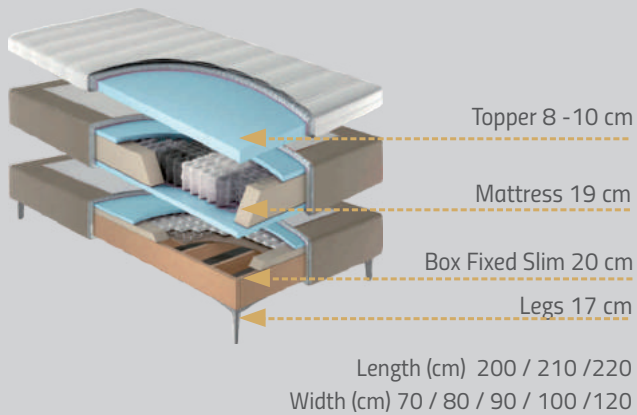

Frame made of solid wood, low 7-zone pocket spring with a height of 3.5 cm, high quality furniture foam. Mattress and topper can be selected according to your preferences.

## Fixed Slim

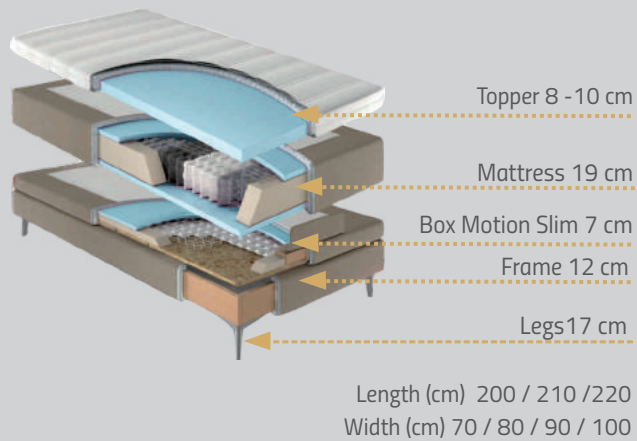

The model with a bed lifting mechanism, the frame of solid wood with 7-zone pocket spring (3.5 cm high), high quality furniture foam. Mattress and topper can be freely selected..

## Motion Slim

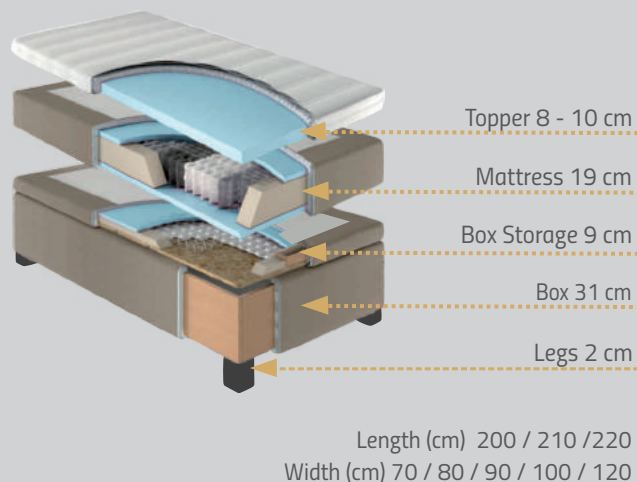

The STORAGE box combines the advantages of a continental and box-type bed. Double box with usable height 31 cm and total volume from 750 cm<sup>3</sup> to 950 cm<sup>3</sup>.

## Storage



**Mattress  
HYR SOFT**

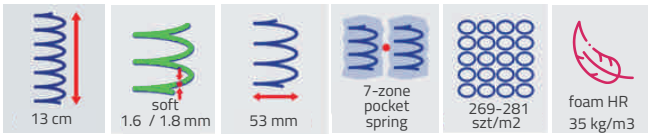
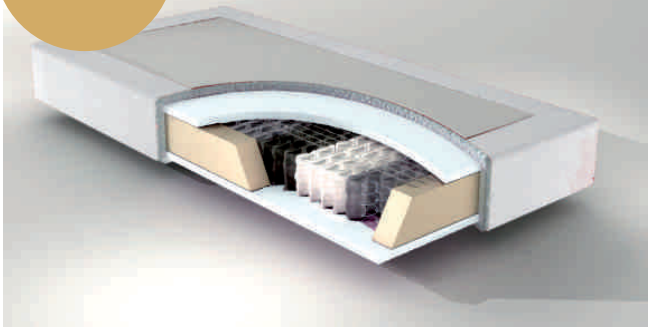

**Mattress  
HYR  
STANDARD**

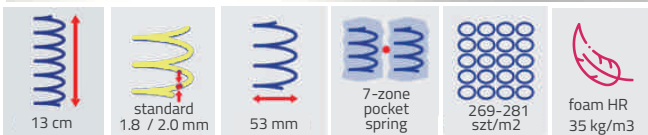
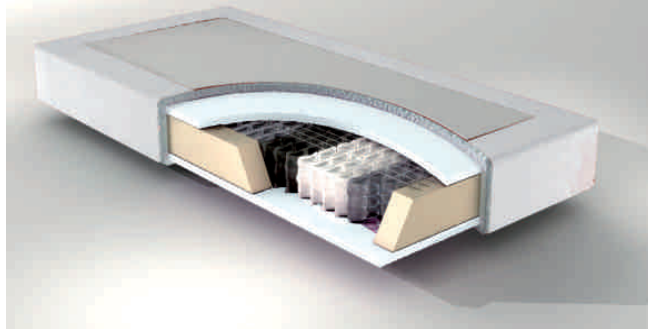

**Mattress  
HYR  
EXTRA**

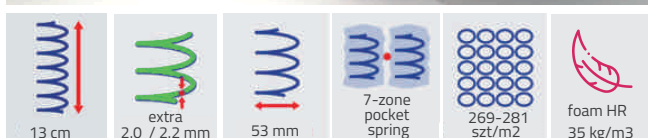
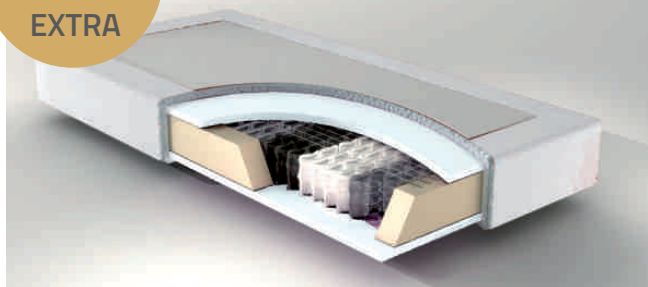

**04 FIRMNESS OF A MATTRESS**

VICINO bed mattresses have built-in pocket springs which are characterized by perfect zonal adjustment to your body weight, thus ensuring ideal cushioning properties. Mattresses are made with seven zones of hardness, arranged in accordance with a human's anatomical structure. This solution causes the body to press evenly against the entire surface of the bed.

The core of each mattress is a high quality 7-zone pocket spring. There are over 270 springs per m<sup>2</sup>. The spring is surrounded by foam profiles. The foam is the same for both the lower and the upper side of the mattress.

All elements that require connection are glued with the highest quality thermo-melting glue. The glued mattress is covered with a special cotton mesh, which facilitates putting on the proper cover and protects the mattress during cleaning the top cover.



### SOFT (1.6/1.8 mm\*)

recommended especially for persons who weigh 60 kg or less, are taller than average and sleep mainly on their back

### MEDIUM - STANDARD (1.8/2.0 mm\*)

recommended especially for persons who weigh 90 kg or less, are taller than average and sleep mainly on their back

### HARD - EXTRA (2.0/2.2 mm\*)

recommended especially for persons who weigh more than 90 kg, are shorter than average and sleep mainly on their side

\* the thickness of the wire from which the springs are made

NOTE: Each type of mattress comes in two options for the firmness of the outer foam – higher (35 kg/m<sup>3</sup>) and lighter (28 kg/m<sup>3</sup>). If you decide to place two separate mattresses on your bed, the mattresses can be of different firmnesses, adapted to the individual using a given mattress.

The symmetry of the firmness zones allows the mattress to be placed on either side. In addition, the mattresses used in VICINO beds are double-sided, which ensures their lasting comfort and long-term satisfaction thanks to the possibility of using them on both sides.

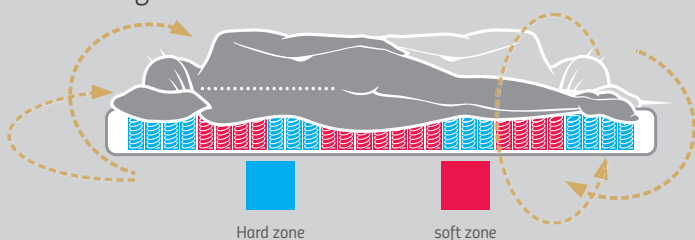

### Mattress ONE SOFT

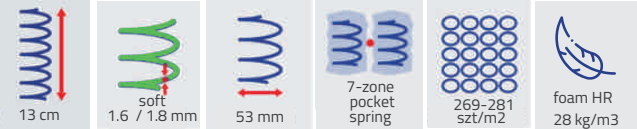
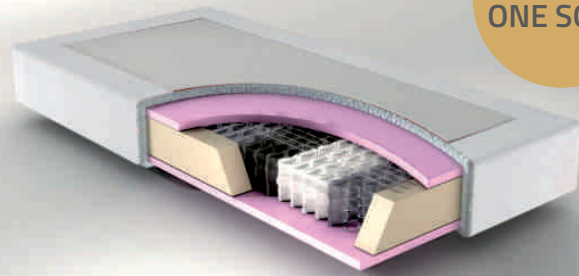

### Mattress ONE STANDARD

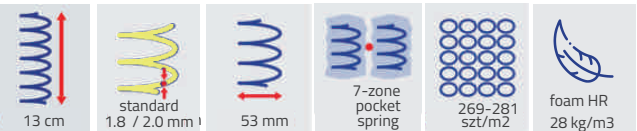
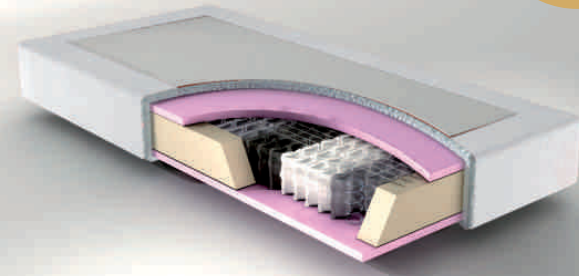

### Mattress ONE EXTRA

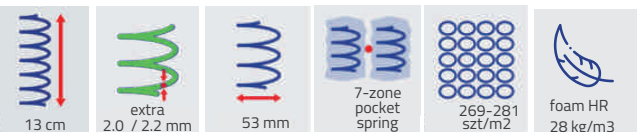
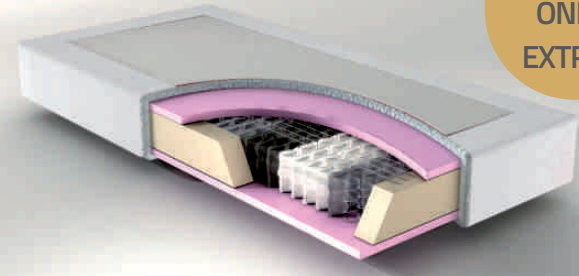

## 05

## HEADBOARDS AND FOOTRESTS



Our beds are available with many models of headboards. Headboards are often the essence of the whole continental bedroom. They're the crowning glory of a bed and its greatest decoration. Their look differs in shape and the type of fabric used.



With the greatest attention to detail, we create headboards in a wide variety of styles. Our headboards are entirely hand-made products.



The headboard can be accompanied by a matching footboard, which is an additional option depending on the users' personal preferences.

ON THE PICTURE: electric bed (MOTION) with a small chest (SLIM) headboard from the SENJE collection



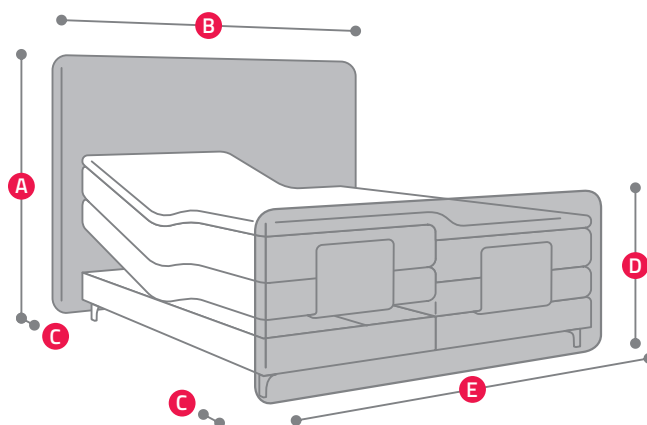

**ALOR**

A	135
B	120 140 160 180 200 220 240
C	11
D	73
E	100 120 140 160 180 200

\* 

**CLARENCE**

A	102 114
B	110 120 140 160 180 200 220
C	15
D	69
E	80 90 100 120 140 160 180 200

\* 

**ROSSA**

A	135
B	120 140 160 180 200 220
C	12
D	70
E	90 100 120 140 160 180 200

\* 

**KING GEORGE**

A	110
B	140 160 180 200 220
C	12

**SENJE**

A	101
B	120 140 160 180 200 220
C	8

**YAPEN**

A	114
B	90 100 140 160 180 200 220 240 260
C	15

**CAYO**

A	115
B	100 150 170 190 210
C	9
D	56
E	80 90 100 120 140 150 160 180 200

\* 

**SHERMAN**

A	110
B	140 160 180 200 220
C	10

**DARU**

A	80 100 112
B	100 130 150 170 190 210
C	17

**CAMPANA**

A	110
B	90 110 120 140 160 180 200 220
C	10

**FRAZER**

A	116
B	90 100 120 140 160 180 200 220
C	12
D	69
E	80 90 100 120 140 160 180 200

\* 

**MANUS**

A	125
B	200 220 240 260
C	20
D	72
E	90 100 120 140 180 200

\* 

\*footrest

| ALOR



| ROSSA



| FRAZER



| KING GEORGE



| CLARENCE



| SENJE



| YAPEN



| SHERMAN



| MANUS



| CAMPANA



| CAYO



| DARU



## FUTON

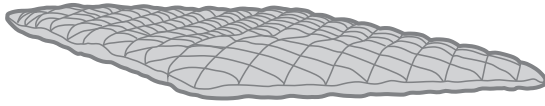

## FIXED

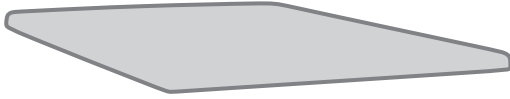

## 07 TYPES OF TOPPER MATTRESSES

Topper - a topper mattress is an additional layer on top of the main mattress, leveling the sleeping surface, providing proper body support while sleeping. Inside the topper is 5 centimeters of foam to choose from four different types.

### Topper GEL 8 cm

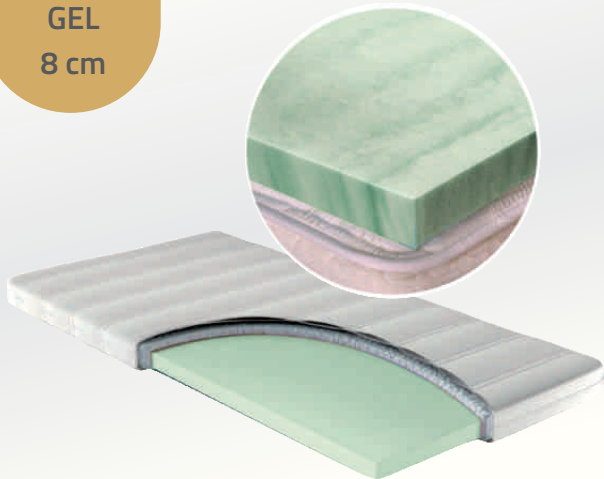

### TOPPER 8 CM GEL

Provides high breathability and excellent moisture exchange. Recommended for people with allergies. It has antibacterial and antifungal properties and is easy to remove stains

- cover made of Polish knitted fabric
- quilted fabric  $350\text{g}/\text{m}^2$
- furniture wadding
- full  $360^\circ$  zip
- 5 cm gel foam |  $48\text{ kg}/\text{m}^2$

### Topper LATEKS 8 cm

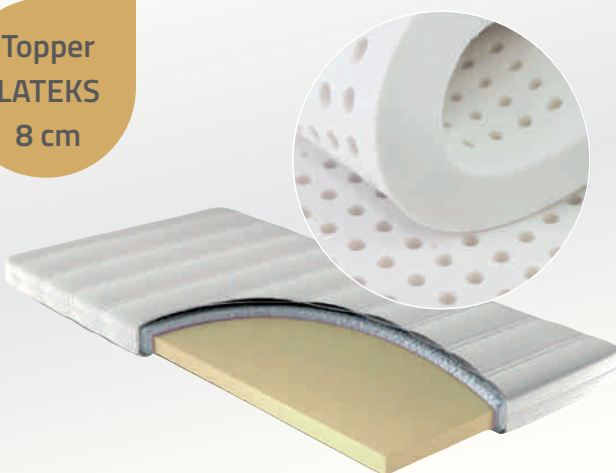

### TOPPER 8 CM LATEKS

Very durable, reduces back pain, wicks moisture well, safe for people with allergies, antibacterial and antifungal properties

- cover made of Polish knitted fabric
- quilted fabric  $350\text{g}/\text{m}^2$
- furniture wadding
- full  $360^\circ$  zip
- 5 cm latex foam |  $48\text{ kg}/\text{m}^2$

The type of topper should be chosen first of all according to the type of bed. FUTON and FIXED toppers are recommended for NORMAL, SLIM and STORAGE beds. MOBILE topper fits DARU bed, and MOTION topper fits electric or box beds. In the next step we focus on the choice of the top mattress filling from a specific type of foam.

MOTION

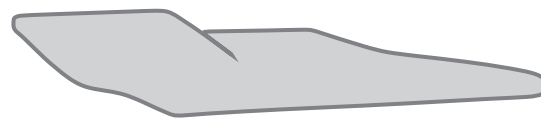

MOBILE

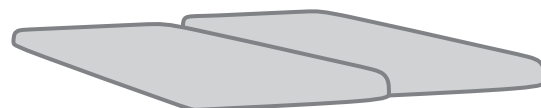

### TOPPER 8 CM VISCO

Made of very soft thermoplastic foam, recommended for people weighing up to 65 kg, Visco foam called "memory", thanks to its thermoplastic properties adapts perfectly to the shape of our body.

- cover made of Polish knitted fabric
- quilted fabric 350g/m<sup>2</sup>
- furniture wadding
- full 360° zip
- 5 cm Visco foam | 50 kg/m<sup>2</sup>



Topper  
VISCO  
8 cm

### TOPPER 8 CM HYR

Top mattress made of highly flexible foam, resistant to deformation, adapts to the user's body, perfectly supports the spine, recommended for people weighing over 90 kg

- cover made of Polish knitted fabric
- quilted fabric 350g/m<sup>2</sup>
- furniture wadding
- full 360° zip
- 5 cm HR foam | 35kg/m<sup>2</sup>

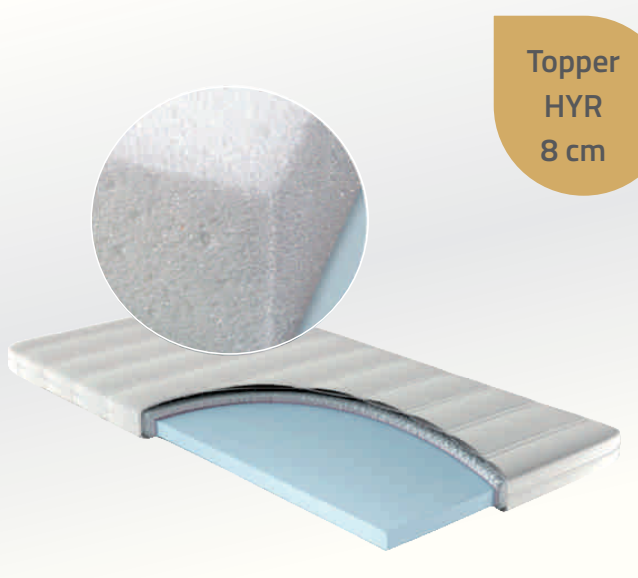

Topper  
HYR  
8 cm



ON THE PICTURE: classical bed (FIXED) with a large chest (NORMAL), headboard from ALOR collection, 10 cm high metal legs, headboard size (height x width) 135 cm x 200 cm

## collection

---

# ALOR



ALOR collection combines elements of the best baroque tradition with modern colors and technology. The beautiful shape of the headboard and footboard (as an additional option) makes ALOR bed a real ornament of each bedroom

The bed is made with the highest precision. All overlaps are laid by hand, and each button is quilted according to the traditional method.

ALOR is also available in an electric version (MOTION). The possibility to control the bed with a wireless remote control makes the ALOR bed even more comfortable.

For people with different requirements there is an option to configure one part of the bed in classic form, and the other with an electric MOTION system. .



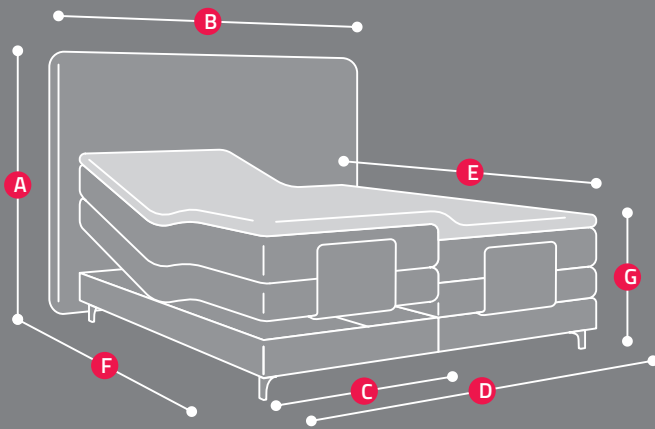

AVAILABLE SIZES(cm)

<b>A</b>	135
<b>B</b>	120 140 160 180 200 220 240
<b>C</b>	70 80 90 100 120
<b>D</b>	140 160 180 200
<b>E</b>	200 210 220
<b>F</b>	211 221 231
<b>G</b>	64

height	73	FOOTREST
width	100 120 140 160 180 200	
thickness	11	



MATTRESS:

- high quality mattress fabric
- upholstery fabric
- pokrowiec wewnętrzny ochraniający piankę tapicerską
- 7-zone pocket spring 13 cm from 269 to 281 pcs/m<sup>2</sup> (depending on mattress size)

TOP MATTRESS – TOPPER:

- height 8 cm
- filled with 5 cm foam
- 360° zipper - for easy removal of the cover
- cover made of ecological fabric

BASE:

- high quality mattress fabric
- upholstery fabric
- 7-zone pocket spring 11 cm from 256 to 268 pcs/m<sup>2</sup> (depending on mattress size)
- additionally in the electric bed version mechanism for lifting the bed

wireless remote control

upholstered frame of solid spruce wood





ON THE PHOTO: a classic bed (FIXED) with a large chest (NORMAL), headboard from the ROSSA collection, 10 cm high metal legs, headboards size (height x width) 135 cm x 180 cm,

collection  
 ———  
**ROSSA**

Beds from the ROSSA collection are a proposal for people attached to the traditional decor, but at the same time wanting to break the style of the interior with a little more modern look.

Symmetrical stitching of the headrest and the double thickness of foam influence the comfort of use, and at the same time its attractive design.

ROSSA bed looks very good when combined with a footrest, emphasizing the character of the furniture.

ROSSA is also available in an electric version. The possibility to control the bed with a wireless remote makes the ROSSA bed even more comfortable.



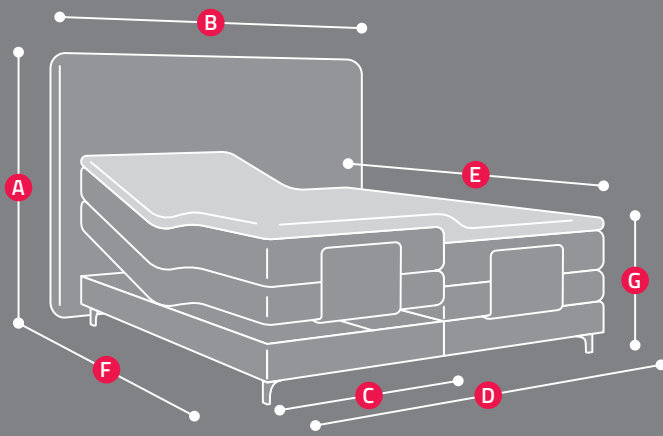

AVAILABLE SIZES(cm)

<b>A</b>	135
<b>B</b>	120 140 160 180 200 220
<b>C</b>	70 80 90 100 120
<b>D</b>	140 160 180 200
<b>E</b>	200 210 220
<b>F</b>	212 222 232
<b>G</b>	64

height	70	FOOTREST
width	90 100 120 140 160 180 200	
thickness	9	



MATTRESS

- high quality mattress fabric
- upholstery fabric
- protective inner cover upholstery foam
- 7-zone pocket spring 13 cm from 269 to 281 pcs/m<sup>2</sup> (depending on mattress size)

BASE:

- high quality mattress fabric
- upholstery fabric
- 7-zone pocket spring 11 cm from 256 to 268 pcs/m<sup>2</sup> (depending on mattress size)
- additionally in the electric bed version mechanism for lifting the bed

TOP MATTRESS - TOPPER:

- 8 cm high, filled with 5 cm foam inside
- 360° zip enabling cover can be removed
- cover made of ecological fabric

upholstered solid wood frame





ON THE PICTURE: electric bed (MOTION) with a small chest (SLIM), headboard from SENJE collection, 17 cm high wooden legs, headboard size (height x width) 101 cm x 180 cm, bed size (width x length of the mattress) 2x80 cm x 200 cm



collection

# SENJE



SENJE collection is a modern version of a continental bed. Its style fits perfectly into modern interiors.

SENJE beds are available only in SLIM version, i.e. with a small box. Thanks to the use of ultra low pocket springs, beds in this collection have an extremely light structure, while maintaining the highest level of comfort.

The proper height of SENJE beds is ensured by 17 cm high slender legs. The impression of lightness is also emphasized by the headboard attached on special holders.

The character of the model is obtained by the horizontal slat made of beech wood (various colours to choose from), which perfectly matches the soft headrest.

The SENJE bed is also available in an electric version.

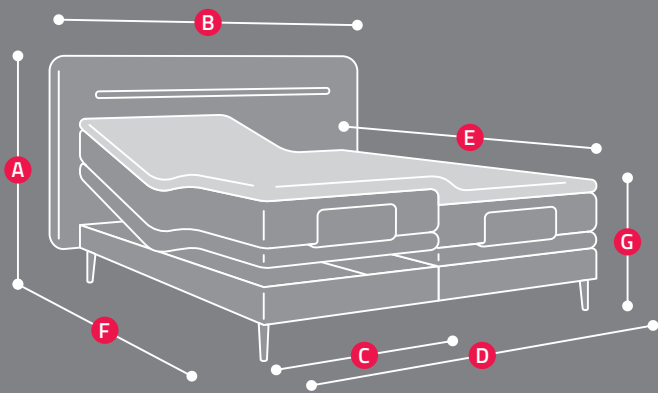

AVAILABLE  
SIZED (cm)

<b>A</b>	101					
<b>B</b>	120	140	160	180	200	220
<b>C</b>	70	80	90	100	120	
<b>D</b>	140	160	180	200		
<b>E</b>	200	210	220			
<b>F</b>	208	218	228			
<b>G</b>	63					

MATTRESS

- high quality mattress fabric
- upholstery fabric
- protective inner cover
- upholstery foam
- 7-zone pocket spring 13 cm from 269 to 281 pcs/m<sup>2</sup> (depending on mattress size)

BASE:

- high quality mattress fabric
- upholstery fabric
- 7-zone pocket spring 3.5 cm from 309 to 313 pcs/m<sup>2</sup> (depending on mattress size)
- additionally in the electric bed version mechanism for lifting the bed

upholstered solid wood frame

LEGS:

- large space between bed and floor (SLIM)
- height of the legs - 17 cm

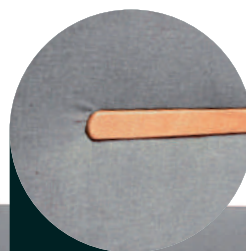

TOP MATTRESS - TOPPER:

- 8 cm high, filled with 5 cm foam inside
- 360° zip enabling cover can be removed
- cover made of ecological fabric





IN THE PHOTO: two separate single beds which can be put together, a headboard from the DARU collection, 10 cm high metal legs, headboard size (height x width) 112 cm x 2 x 170 cm, bed size (width x length of mattress) 2x100 cm x 200 cm

colletion

# DARU

The DARU collection is addressed to people who value change. The biggest advantage of DARU beds is the variety of solutions and their mobility.

An advantage of the model is the removable cover, both on bed as well as on the headboard. This makes it possible to change the look of the furniture, as well as easy cleaning.

The DARU bed consists of four separate elements, easy to transport. It is also ideal for places of collective accommodation, such as hotels, guest houses or holiday centres.

DARU single beds can be put together and thanks to wheels installed in the back legs, they can also be easily moved.



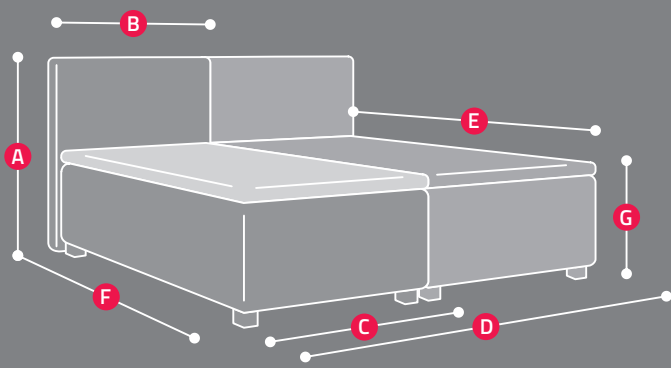

AVAILABLE SIZES (cm)

<b>A</b>	80	100	112						
<b>B</b>	80	90	100	130	150	170	190	210	
<b>C</b>	70	80	90	100	120				
<b>D</b>	140	160	180	200					
<b>E</b>	200	210	220						
<b>F</b>	217	227	237						
<b>G</b>	62								

**HEADREST:**

- removable upholstery cover

**TOP MATTRESS - TOPPER:**

- 8 cm high, filled with 5 cm foam inside
- zip enabling cover can be removed
- cover made of ecological fabric

**UPPER MATTRESS:**

- 7-zone pocket spring 13 cm

**BOTTOM MATTRESS:**

- 7-zone pocket spring 11 cm

Removable cover with sewn-in furniture padding

Upholstered spruce solid wood frame 12 cm

Legs 10 cm

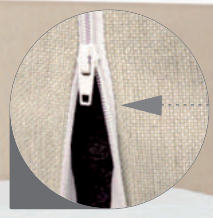

Zip in the back of the headrest



ON THE PICTURE: STORAGE bed with an openable container, headboard from the CAYO collection, 2.2 cm high metal legs, headboard size (height x width) 115 cm x 210 cm, bed size (width x length of the mattress) 2x80 cm x 200 cm

## collection

---

# STORAGE

The STORAGE collection is a proposal for small spaces. Its advantage is simple form and practicality of use. The STORAGE collection features two different bed models with deep and spacious bed linen boxes of approx. 30 cm in height. Comfort is complemented with a layer of 7-zone pocket springs (35 mm high) with over 300 springs/m<sup>2</sup>.

The base of the KOOFER model is made of 15 mm thick plywood. The top layer of the box is a frame made of solid wood and GOODSITE slats with a glass fibre core. The Koofer model opens along the long side, which allows access to the entire surface of the box.

The base of the NORA model is constructed from 18 mm thick anthracite-coloured laminated board. In the NORA model the chest can open both on the short and long side.

..\*The STORAGE collection requires two single mattresses. We also suggest using a top mattress in the MOTION version for easier opening of the box.





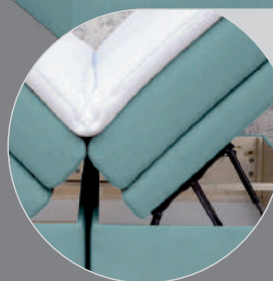
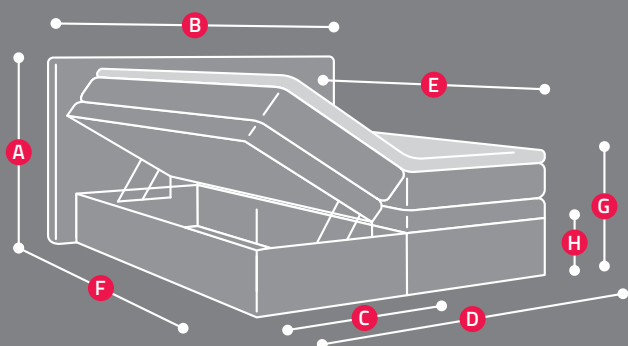

AVAILABLE SIZES (cm)

<b>A</b>	115				
<b>B</b>	100	150	170	190	210
<b>C</b>	70	80	90		
<b>D</b>	140	160	180		
<b>E</b>	200	210	220		
<b>F</b>	209	219	229		
<b>G</b>	70				
<b>H</b>	30				

height	56	FOOTREST									
width	80	90	100	120	140	150	160	180	200		
thickness	8,5										

ON THE PICTURE BELOW: STORAGE NORA bed, opening container on the shorter side, headrest from CLARENCE collection, metal legs 2.2 cm high, headrest size (height x width) 114 x 210 cm, bed size (width x length of the mattress) 2 x 80 cm x 200 cm

MATTRESS:

- high quality mattress fabric
- upholstery fabric
- protective inner cover
- upholstery foam
- 7-zone pocket spring 13 cm from 269 to 281 pcs/m<sup>2</sup> (depending on mattress size)

TOP MATTRESS – TOPPER:

- 8 cm high, filled with 5 cm foam inside
- 360° zip enabling cover can be removed
- cover made of ecological fabric

BASE:

- high quality mattress fabric
- upholstery fabric
- 7-zone pocket spring 3.5 cm from 309 to 313 pcs/m<sup>2</sup> (depending on the size of the mattress)
- laminated board

BOX:

- upholstered box made of laminated board capacity from 375 cm<sup>3</sup> to 475 cm<sup>3</sup> (for a double bed x 2)





model

# FRAZER

ON THE PICTURE BESIDE:  
classic bed (FIXED) with a large chest (NORMAL)  
headboard from the FRAZER collection,  
10 cm high metal legs,  
headboard size (H x W) 16 cm x 180 cm,  
bed size (width x length of mattress)  
2 x 80 cm x 200 cm

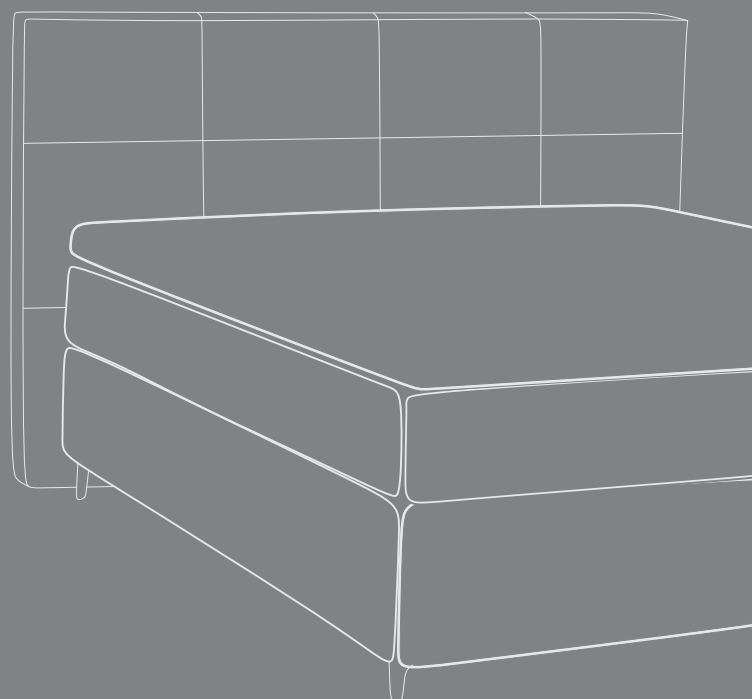

model

# KING GEORGE

ON THE PICTURE BESIDE:  
classic bed (FIXED) with a small chest (SLIM),  
headboard from the KING GEORGE collection,  
17 cm high wooden legs,  
headboard size (H x W) 110 cm x 180 cm,  
bed size (width x length of mattress)  
2 x 80 cm x 200 cm





model

# CAMPANA

ON THE PICTURE BESIDE:  
electric bed (MOTION) with a small chest (SLIM)  
headboard from CAMPANA collection,  
17 cm high wooden legs,  
headboard size (H x W) 110 cm x 180 cm,  
bed size (width x length of mattress)  
2 x 80 cm x 200 cm

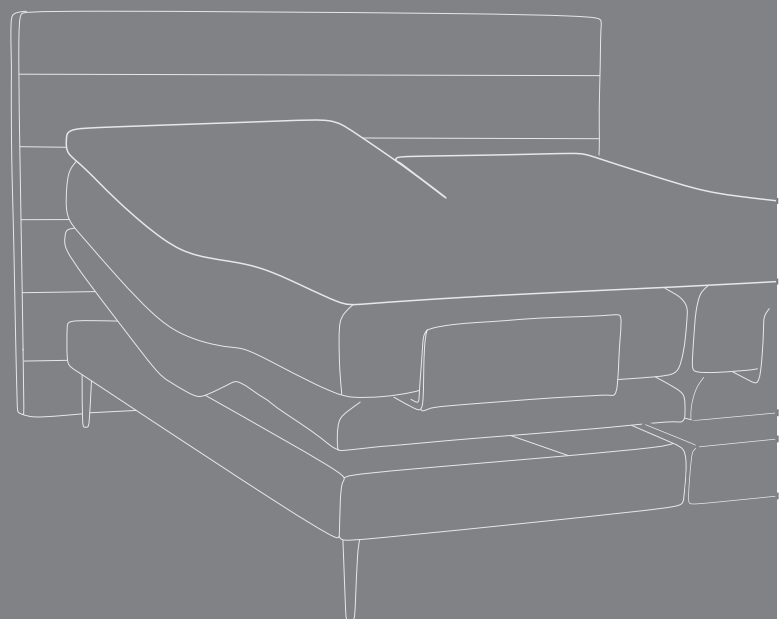

model

# CLARENCE

ON THE PICTURE BESIDE:  
classic bed (FIXED) with a small chest (SLIM),  
a headboard from CLARENCE collection,  
17 cm high wooden legs,  
headboard size (H x W) 114 cm x 180 cm  
bed size (width x length of mattress)  
2 x 80 cm x 200 cm

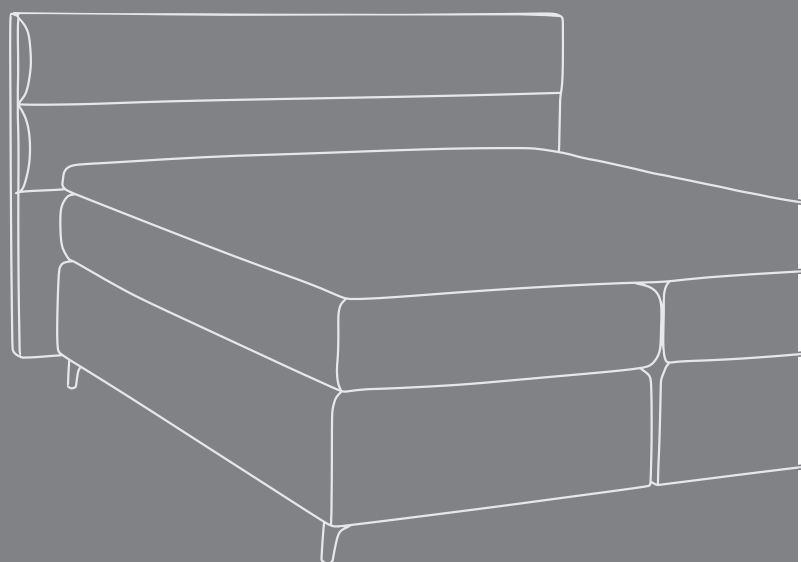



model

# SHERMAN

ON THE PICTURE BESIDE:  
electric bed (MOTION) with a large chest (NORMAL),  
headboard from SHERMAN collection,  
10 cm high metal legs,  
headboard size (H x W) 110 cm x 180 cm,  
bed size (W x D of the mattress) 2 x 80 cm x 200 cm

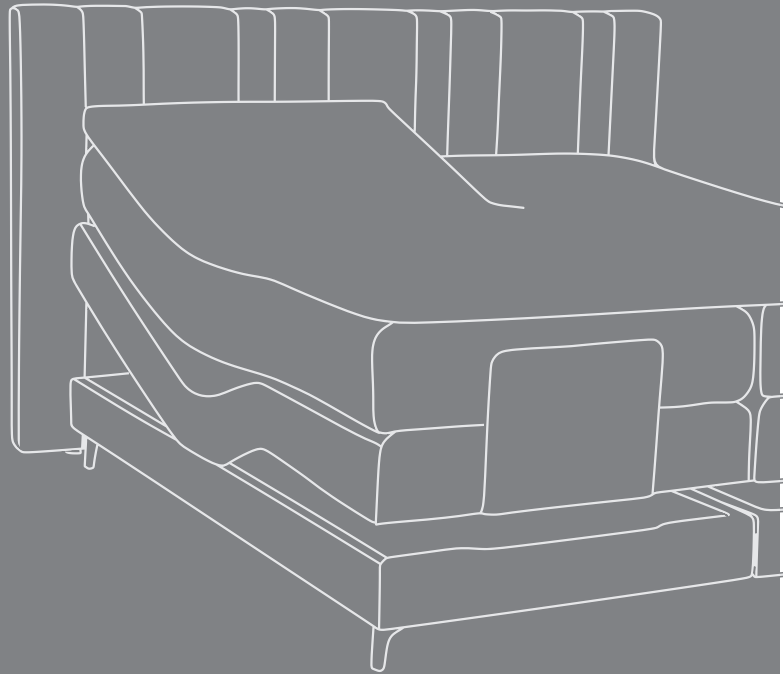

model

# YAPEN

ON THE PICTURE BESIDE:  
classic bed (FIXED) with a large chest (NORMAL)  
headboard from YAPEN collection,  
10 cm high metal legs,  
headboard size (H x W) 114 cm x 180 cm,  
bed size (width x length of mattress)  
2 x 80 cm x 200 cm

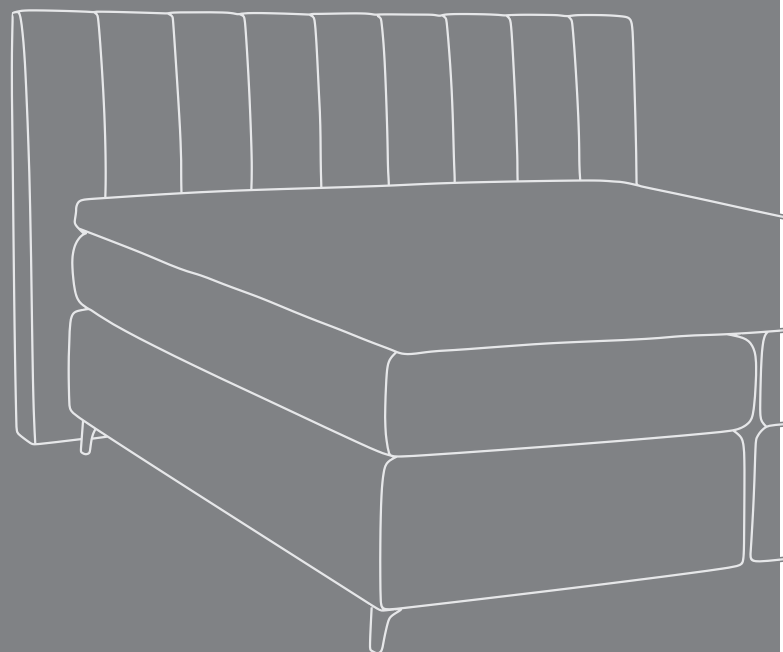





model

# MANUS

ON THE PICTURE BESIDE:  
electric bed (MOTION) with a small chest (SLIM)  
headboard from MANUS collection,  
17 cm high wooden,  
headrest size (H x W) 125 cm x 220 cm,  
bed size (width x length of mattress)  
2 x 80 cm x 200 cm



model

# MISOOL

ON THE PICTURE BESIDE:  
classic bed (FIXED) with a large box (SLIM),  
headrest from MISOOL collection,  
wooden legs 7 cm high,  
headrest size (H x W) 150 cm x 220 cm,  
bed size (width x length of mattress)  
2 x 80 cm x 200 cm

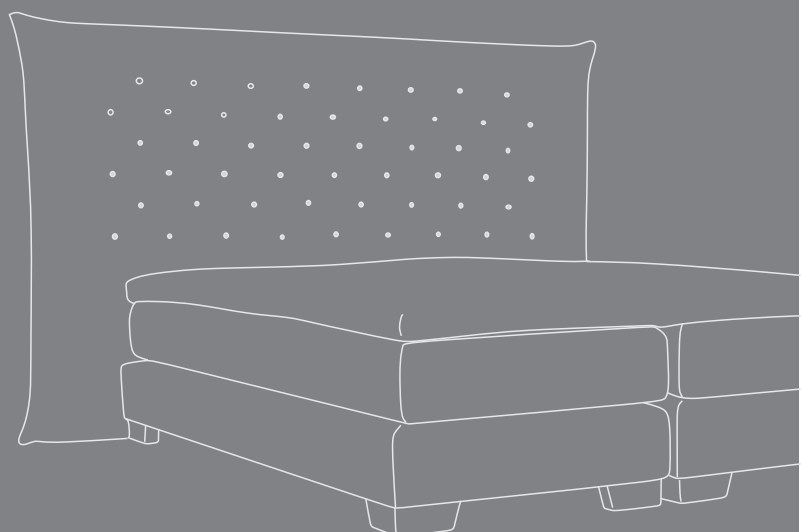

## WHAT IS AN UPHOLSTERED BED?



Upholstered furniture makes every interior gain a subtle and cosy atmosphere. Thanks to a wide range of colours of upholstery fabrics, as well as their types, adjusting a bed to the look of a bedroom is extremely easy.



We produce upholstered beds with standard, simple headboards which are perfect for minimalist bedrooms, as well as elegant, quilted headboards perfectly suited to stylish interiors.



Upholstered beds are suitable for any bedroom. They can be a base for your existing or dreamed of mattress. We offer sets with or without a mattress in a whole range of fabric structures and colours.

# 1

### FRAME AND RACK

Beechwood frame, wooden or metal rack with spring bars that can be raised depending on the model

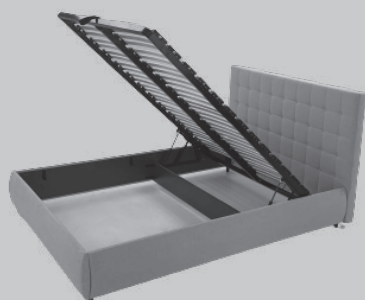

# 2

### MATTRESS

with built-in pocket springs, having 7 hardness zones arranged in accordance with the human anatomical structure

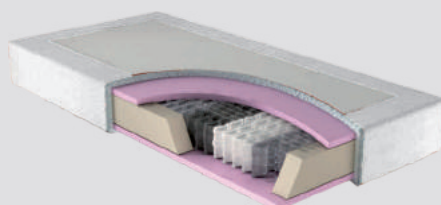

# 3

### HEADBOARD

Upholstered, it has a decorative as well as a practical function, providing a comfortable semi-seated position



## FEASY MATTRESS

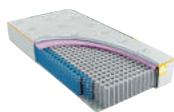

The Feasy mattress is a unique product made of 100% pocket springs with a height of 17 cm. Inside the mattress, there are as many as 450 individual springs, where the central part consists of springs with a wire thickness of 2.0 mm, while the external part consists of springs with a wire thickness of 2.4 mm. Thanks to this structure, comfortable use of the mattress is ensured also when getting up from the bed.



The mattress fabric used has antibacterial properties. The use of springs with such a height ensures optimal air circulation and internal ventilation of the entire mattress. These solutions result in longer life-span of the mattress and improve its hygienic qualities.



ON THE PICTURE: Upholstered bed STORAGE ROUND, headboard LOS NEO

# TYPES OF UPHOLSTERED BEDS

The VICINO upholstered bed configurator helps you to make the right choice of individual elements in terms of your individual needs and requirements.

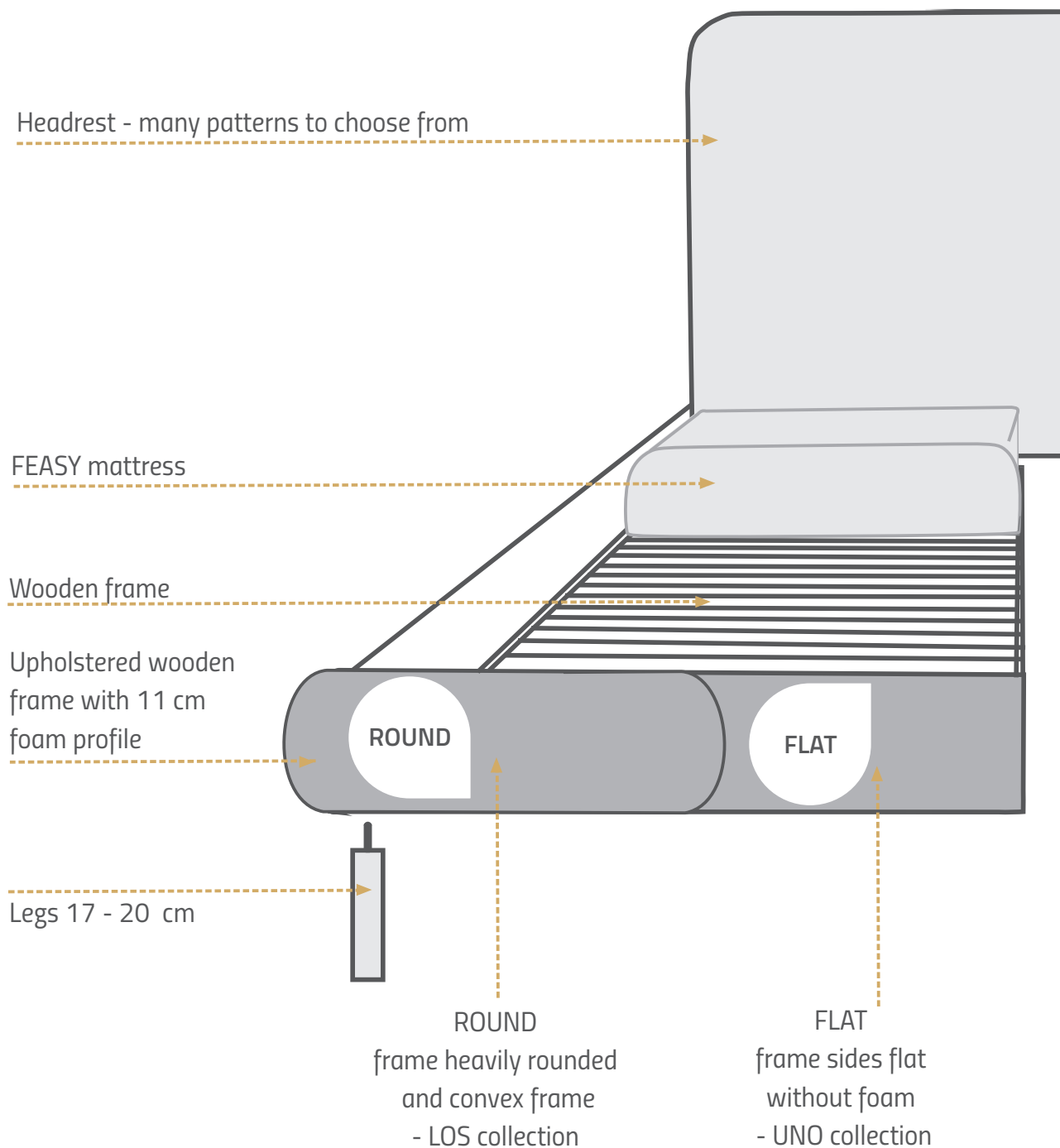

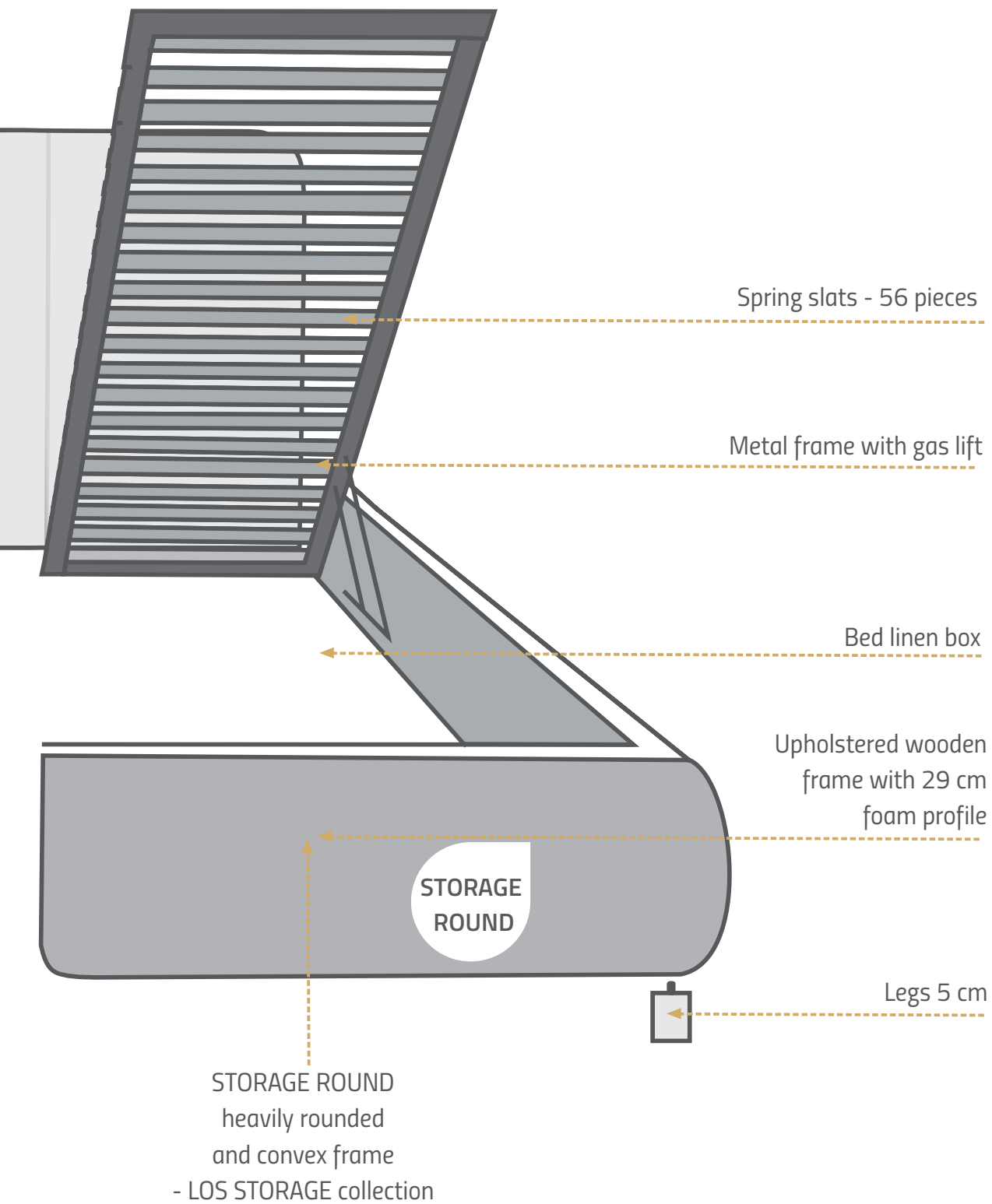



model

# UNO BASE

ON THE PICTURE BESIDE  
Upholstered bed FLAT,  
headboard from Uno collection smooth  
with rounded corners, height 110 cm,  
20 cm high solid wood legs,  
headboard size (height x width) 110 cm x 160 cm,  
bed size (width x length of mattress)  
160 cm x 200 cm

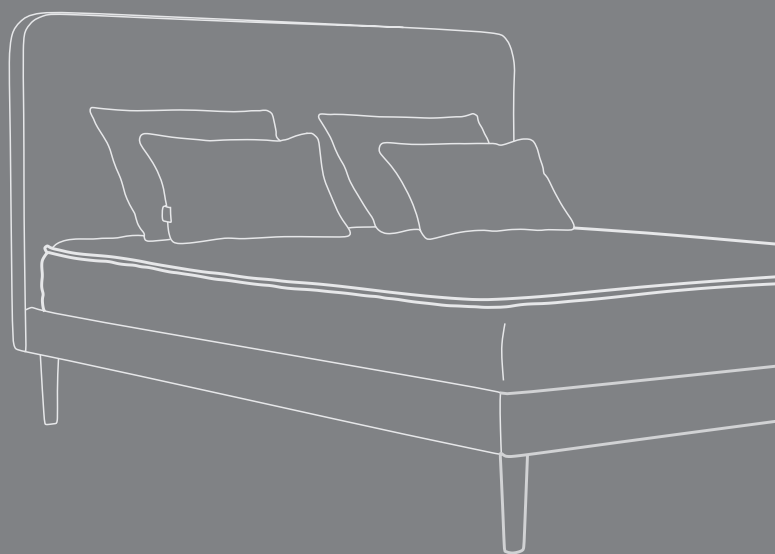

model

# UNO GEO

ON THE PICTURE BESIDE  
Upholstered bed FLAT,  
headboard from Uno collection smooth  
with rounded corners, height 110 cm,  
20 cm high solid wood legs,  
headboard size (height x width) 110 cm x 160 cm,  
bed size (width x length of mattress)  
160 cm x 200 cm

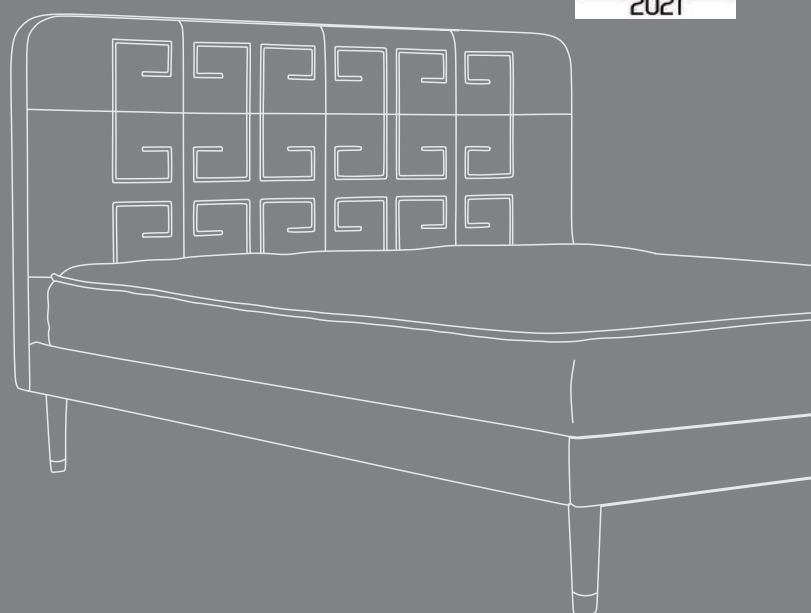

LAUREAT  
NAGRODY

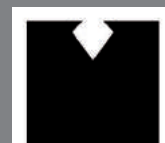

DIAMENT  
meblarstwa  
2021





model

# UNO LINE

ON THE PICTURE BESIDE

Upholstered bed FLAT, headboard from Uno collection smooth with rounded corners, additionally with sewn-in kedra in contrast colour, headboard height 110 cm, solid wood legs height 20 cm, headboard size (height x width) 110 cm x 160 cm, bed size (width x length of mattress) 160 cm x 200 cm

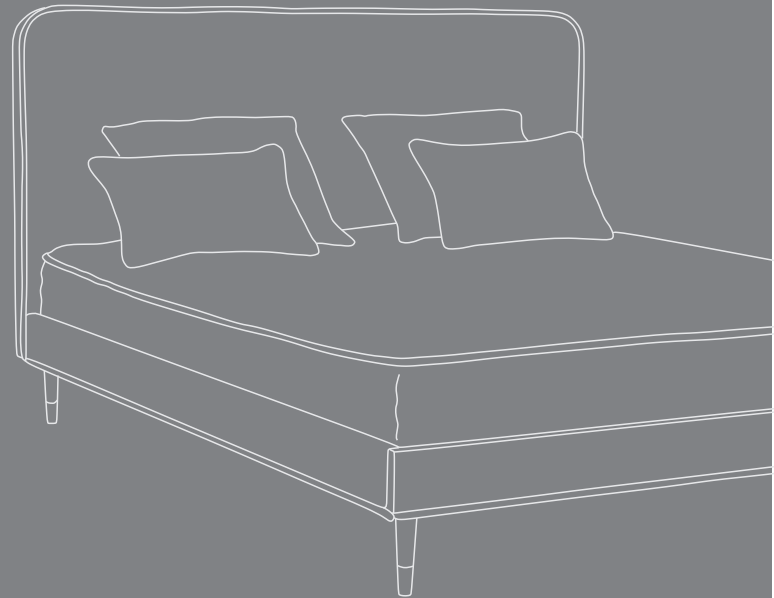

model

# UNO POCKET

ON THE PICTURE BESIDE

Upholstered bed FLAT, headboard from Uno collection smooth with a dedicated pocket for trinkets 110 cm high, 20 cm high solid wood legs, headboard size (height x width) 110 cm x 160 cm, bed size (width x length of mattress) 160 cm x 200 cm

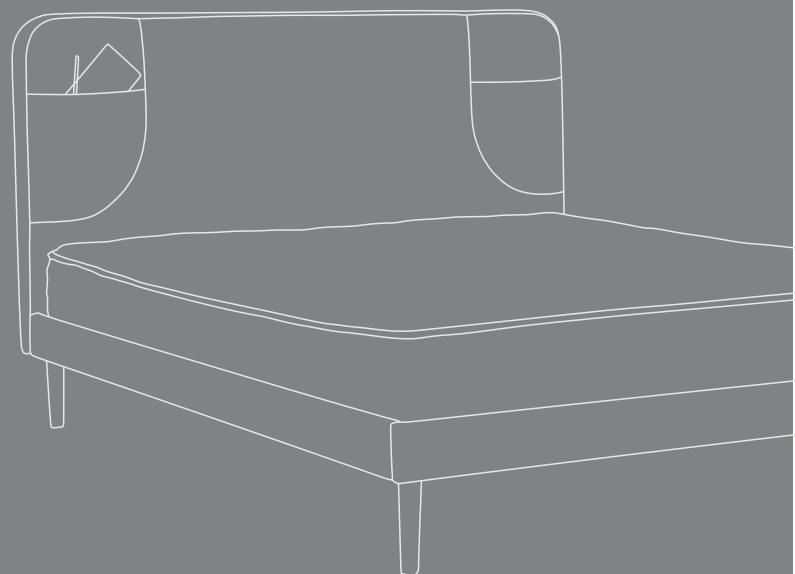



model

# UNO SOFT

ON THE PICTURE BESIDE

Upholstered bed FLAT, headboard from the Uno collection with finish imitating a pillow, 110 cm high, 20 cm high solid wood legs, headboard size (height x width) 110 cm x 160 cm  
size of bed (width x length of mattress)  
160 cm x 200 cm

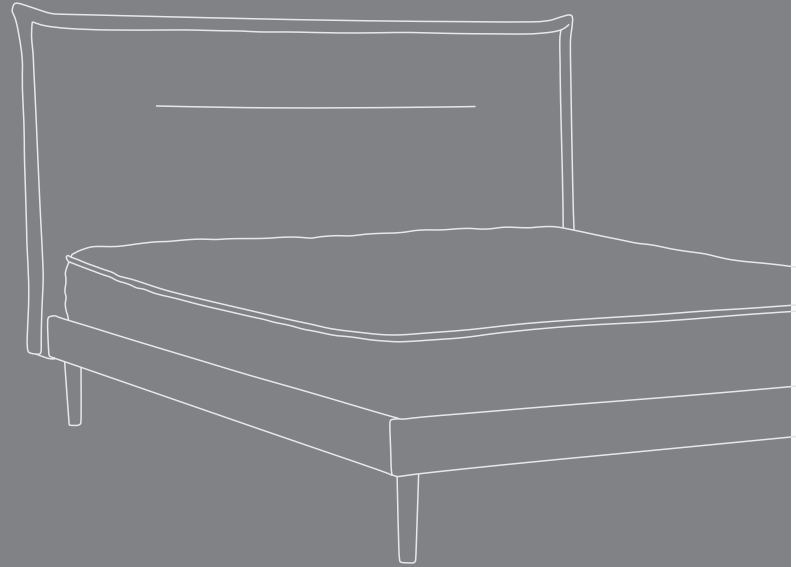

model

# LOS BASE

ON THE PICTURE BESIDE

ROUND STORAGE upholstered bed, headboard from LOS BASE collection smooth and universal. Rounded frame sides achieved by the use of profiled foam, 5 cm high solid wood legs, headboard size (height x width) 90 cm x 160 cm, bed size (width x length of mattress)  
160 cm x 200 cm



\*RIGHT: ROUND upholstered bed, LOS BASE headboard



model

# LOS ORE

ON THE PICTURE BESIDE

Upholstered bed STORAGE ROUND,  
headboard from LOS ORE collection with ears,  
decorated with vertical stitching  
and upholstered buttons,  
5 cm high solid wood legs,  
headboard size (height x width) 90 cm x 160 cm,  
size of bed (width x length of mattress)  
160 cm x 200 cm

\* RIGHT: Upholstered bed ROUND, headboard LOS ORE

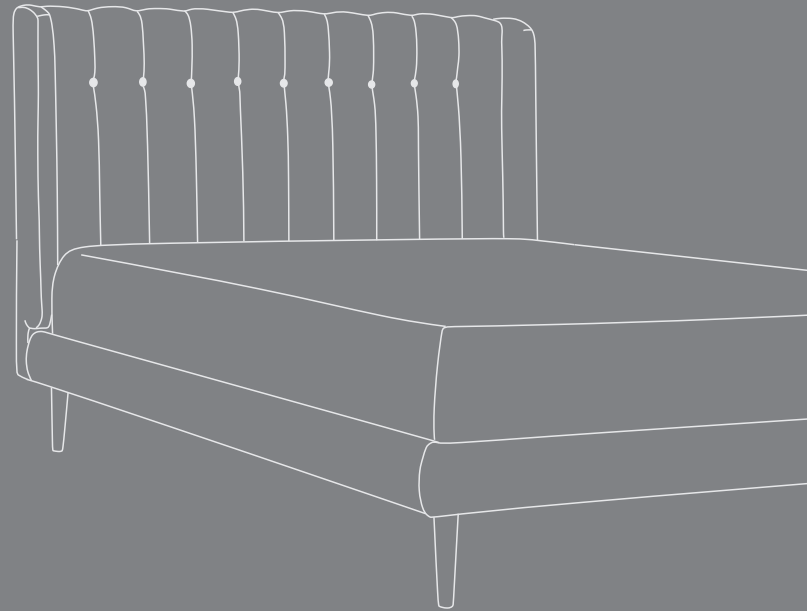

model

# LOS PORO

ON THE PICTURE BESIDE

ROUND upholstered bed,  
headboard from LOS PORO collection  
with delicate vertical stitching,  
5 cm high solid wood legs,  
headboard size (height x width) 160 cm x 90 cm,  
bed size (width x length of mattress)  
160 cm x 200 cm

\*RIGHT: Upholstered bed STORAGE ROUND, headboard LOS PORO

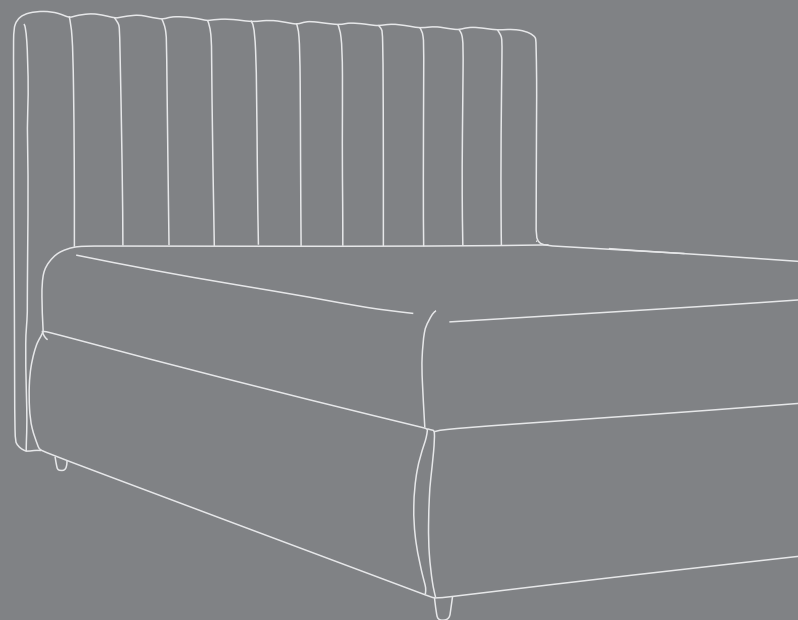



vicino  
la cultura dei sogni

model

# LOS ROCCO

ON THE PICTURE BESIDE  
ROUND upholstered bed,  
headboard from LOS ROCCO collection  
quilted with upholstered buttons,  
17 cm high solid wood legs,  
headboard size (height x width) 90 cm x 160 cm,  
bed size (width x length of mattress)  
160 cm x 200 cm

\*RIGHT: Upholstered bed STORAGE ROUND, headboard LOS ROCCO

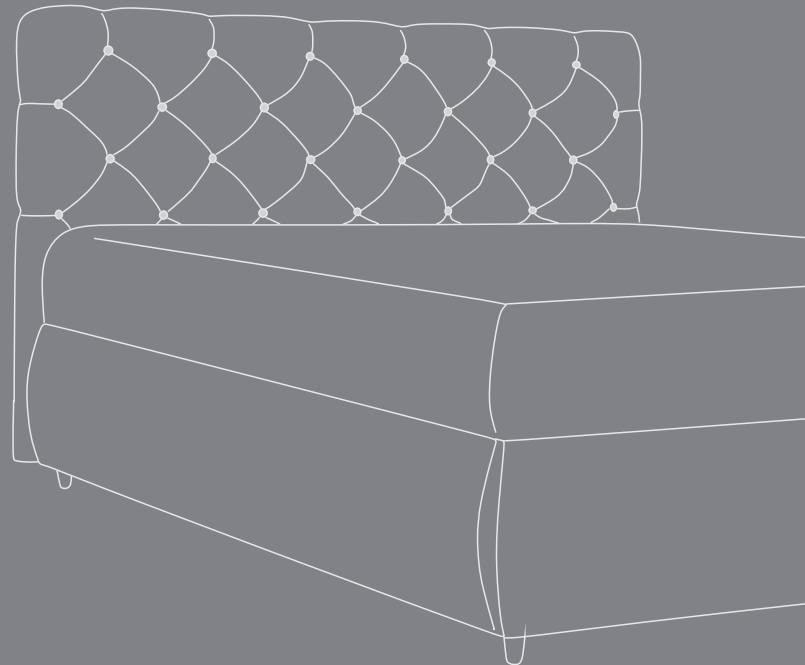

model

# LOS NEO

ON THE PICTURE BESIDE:  
ROUND upholstered bed,  
headboard from LOS NEO collection with  
decorative geometrical stitching,  
17 cm high solid wood legs,  
headboard size (height x width) 160 cm x 104 cm,  
bed size (width x length of mattress)  
160 cm x 200 cm

\*STORAGE ROUND upholstered bed, headboard LOS NEO

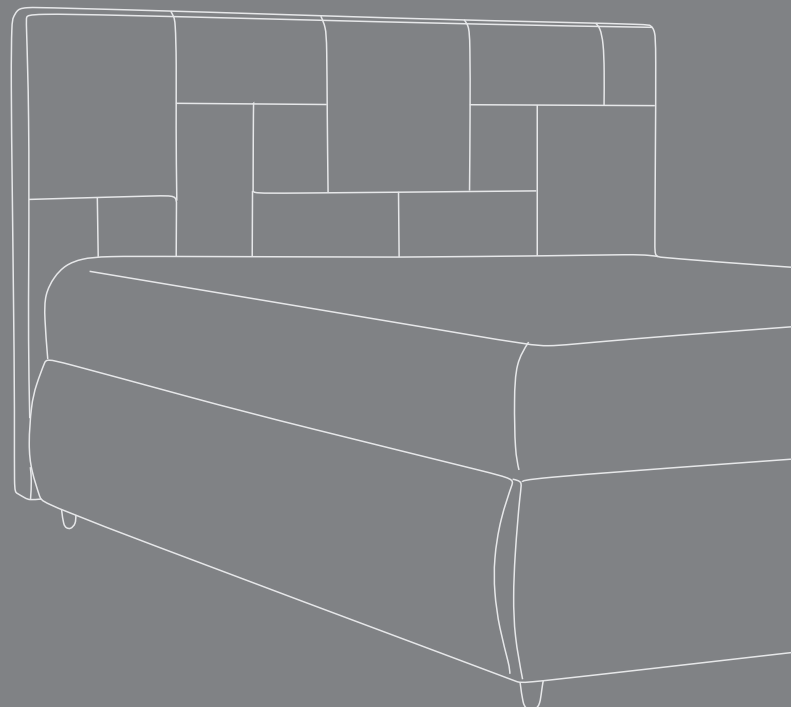



**Nicino**  
la cultura dei sogni



**Nicino**  
la cultura dei sogni



model

# LOS DOT

ON THE PICTURE BESIDE  
STORAGE ROUND upholstered bed,  
headboard from LOS DOT collection  
with delicate stitching and upholstered buttons,  
5 cm high solid wood legs,  
headboard size (height x width) 104 cm x 160 cm,  
bed size (width x length of mattress)  
160 cm x 200 cm

\*ROUND upholstered bed, LOS DOT headboard

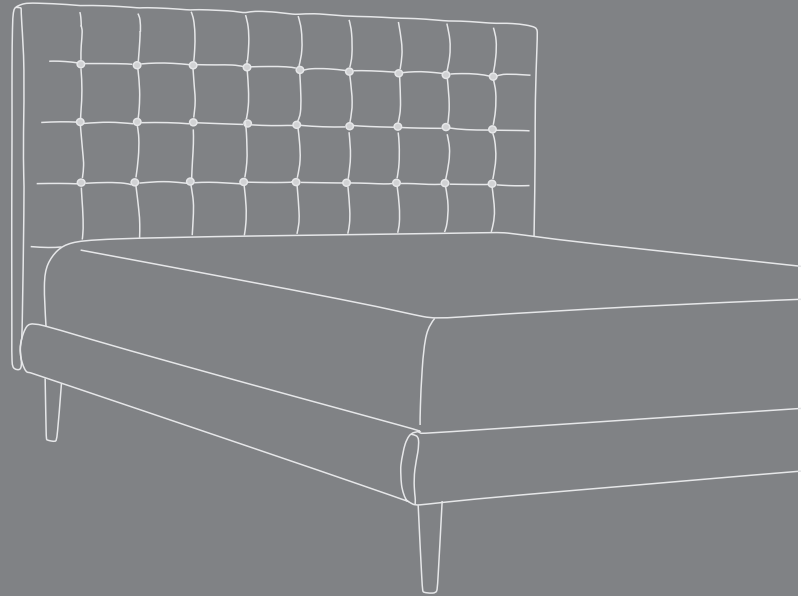

model

# LOS BOW

ON THE PICTURE BESIDE:  
headboard from LOS BOW collection in the shape  
of semicircle with three upholstered buttons,  
5 cm high solid wood legs,  
headboard size (height x width) 104 cm x 160 cm,  
bed size (width x length of mattress)  
160 cm x 200 cm

\*RIGHT: ROUND upholstered bed, LOS BOW headboard

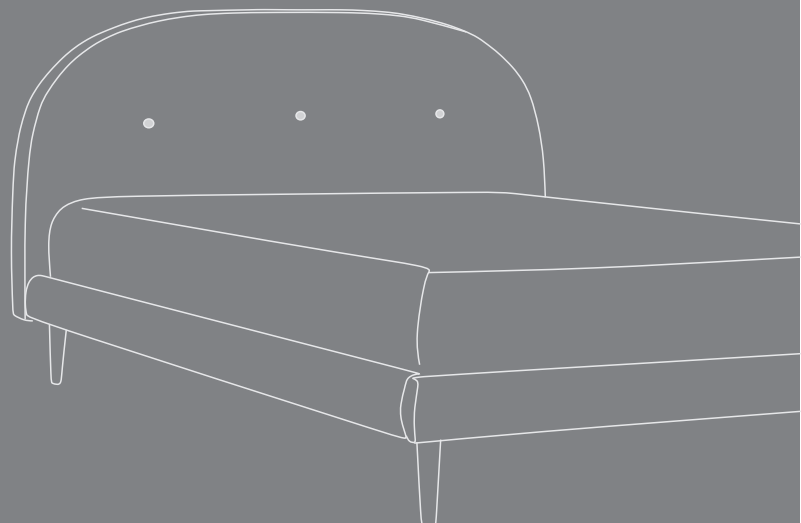

08 ACCESSORIES

09



LEG NA066JP  
height: 100 mm  
Aluminium



LEG NA083JP  
height: 100 mm or 170 mm  
Aluminium



LEG NA202JP  
height.: 170 mm  
Aluminium



LEG NA134SJP  
height.: 100 mm  
Aluminium



LEG NA97-5JP  
height.: 100 mm or 170 mm  
Aluminium (black, mat)



LEG NA97-3JP  
height.: 100 mm or 170 mm  
Aluminium



LEG 130GL  
height.: 170 mm  
Solid wood

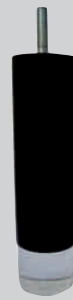

LEG 131 GL  
height.: 170 mm  
Wood/plexi



LEG 162GL  
height.: 100 mm  
Solid wood



LEG 168GL  
height.: 100 mm  
Solid wood



LEG NA168-TJP  
height.: 22 mm | fi=45 mm  
Aluminium



LEG 63590351  
height.: 23-30 mm | fi=55 mm  
Plastic



Leg wood natural  
height.: 100 mm  
Solid wood



LEG ND016JP  
height.: 170 mm  
Solid wood

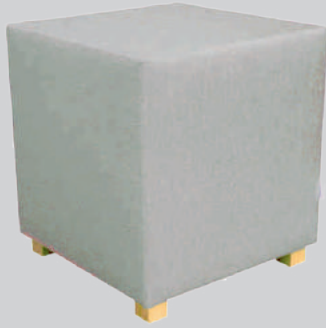

POUFFE VISTA  
W: 46 cm / D: 46 cm  
H: 50 cm



BOX PETTO+  
W: 125 cm / D: 41 cm  
H: 50 cm



POUFFE PICO  
W: 102 cm / D: 50 cm  
H: 52/74 cm



BOX PETTO  
W: 125 cm / D: 41 cm  
H.: 50 cm



DECORATION CUSHION BRACCIO (50 x 50 cm)  
Antiallergic filling made of silicone polyester fiber.



DECORATION CUSHION AJON (60 x 30 cm)  
Cover with a zipper. Washable.  
Antiallergic filling made of silicone polyester fiber.



BEDDING CUSHION PUNA (60 x 50 cm)  
Cushion with feedstock of siliconized polyester fiber resembling natural down, weight 600 g. The soft cover is additionally quilted with a layer of cotton wool.



DECORATION CUSHION BIKO (50 x 30 cm)  
Cover with a zipper. Washable.  
Antiallergic filling made of silicone polyester fiber.



ON THE PHOTO : Classic bed NORMAL with small box , headboard from SHERMAN collection

  
 la culla dei sogni

  
 Business Gepard

2015/2016/2017/2018

  
 MOCNA FIRMA  
 Godna Zaufania

2015/2016/2018

  
 Efektywna  
 Firma

2016/2017/2018

Powered by:  
**BOVELLI BEDDING SP.Z O.O.**  
 Fałkowo 152  
 62-260 Łubowo | POLSKA  
 kontakt@bovelli.com | info@vicino.eu  
 www.vicino.eu

  
 GAZELE  
 BIZNESU Puls  
 Biznesu

2018

  
 ORZEŁ  
 POWIATU  
 GNIEŹNIENSKIEGO  
 DLA PRZEDSIĘWZĘCZOŚCI

2019

  
 DIAMENT  
 meblarstwa

2021